



USER MANUAL

www.laney.co.uk

 British Engineering from the
Black Country United Kingdom



Dear Player,

Thank you very much for purchasing your new Laney product and becoming part of the worldwide Laney family. Each and every Laney unit is designed and built with the utmost attention to care and detail, so I trust yours will give you many years of enjoyment.

Laney products have a heritage which stretches back to 1967 when I first began building valve amplifiers in my parent's garage.

Since then we have moved on from strength to strength developing an extensive range of guitar, bass, public address, multi instrument and keyboard amplification products along with a list of Laney endorsees that includes some of the world's most famous and respected musicians.

At the same time we believe we have not lost sight of the reason Laney was founded in the first place - a dedication to building great sounding amplification for working musicians.

Warm Regards,



Lyndon Laney CEO

INTRODUCTION

It's not a PA speaker! It's a guitar 200W Xpansion cabinet

In a regular amplifier set up, a speaker is connected to an amps output section and both the speaker and the output section work together to produce a dynamic guitar tone.

Using an IRT-X with a regular amplifier set up is simple, the IRT-X is connected **BETWEEN** the amplifiers output section and it's speaker.

This does not alter the amps sound in any way but the IRT-X works in conjunction with the amplifiers output section and speaker to produce your guitar tone but with

- More - **PUNCH**
- More - **POWER**
- More - **DYNAMICS**
- More - **HIGHS & LOWS**
- More - **CLARITY**
- More - **DEFINITION**

Conventional set-up

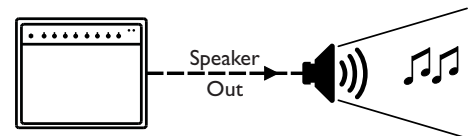

IRT-X set-up

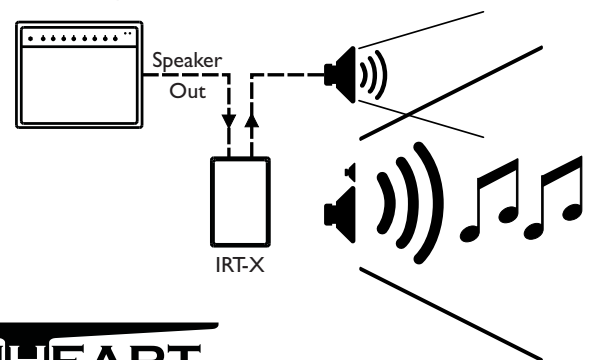

It works with whatever guitar, amp and pedals you use and we can happily say it's the best **YOUR** guitar sound will ever sound!

Try it and see...

 **IRT-X**
AS AN
EXTENSION CABINET
TO A COMBO WITH
FX & BACKING



 **IRT-X**
USE WITH
AN IRT-STUDIO

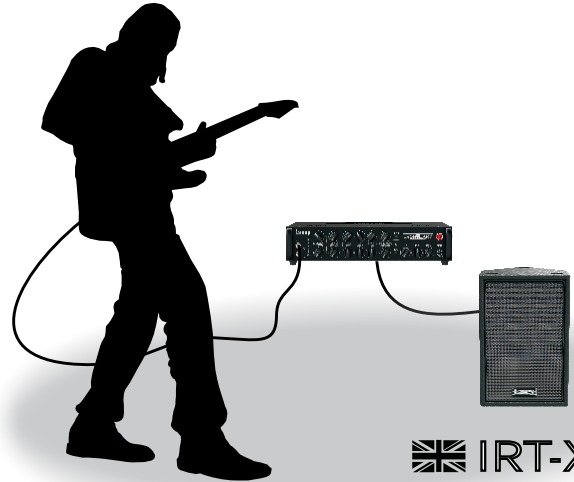

*So how are you
going to use yours?.....*



 **IRT-X**
AS A
PERSONAL
WEDGE MONITOR

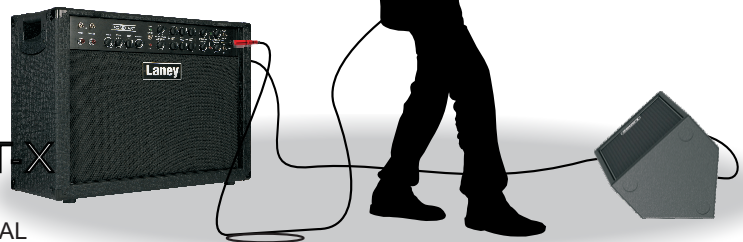

www.Laney.co.uk



 **IRT-X**
 USE WITH
 ACOUSTIC AN AMPLIFIER



 **IRT-X**
 USE AS A
 WET - DRY - WET
 SET UP WITH
 FX & BACKING

**.....Your set-up, Your way,
the possibilities are endless!**

The key is - Electro- Mechanical Reactive Linking (ERL)

Unlike an extension cabinet - which sits after your output section, the IRT-X sits BETWEEN your amps output section and your amps speaker and cleverly mimics the response characteristics of your amp and speaker combination.

Unlike most guitar speakers, which are commonly, rolled off above 4Khz the IRT-X houses a high quality flat response 8" Driver and a 1" Compression Driver. As soon as you connect the IRT-X, YOUR guitar tone has the capability for far more highs and lows, which means more tone!

Used in its most straightforward application the IRT-X gives you more of YOUR tone! More of your guitar - more of your amp!

And since it's YOUR tone what better than to use it as your own personal guitar monitor on stage – every gigging musician has run into problems hearing themselves on stage.

The IRT-X gives YOU the solution to hearing YOUR own tone on stage.

Better tone that you can hear – it's a win-win situation!

JUST MORE OF YOUR TONE

THE BEST SIGNAL PATH

Guitar players love effects but sometimes they can get in the way of YOUR tone – the best tone is the simplest tone.

The IRT-X houses a stereo FX loop!

Plug YOUR effects into the IRT-X and YOU get all the benefit of your unadulterated guitar tone – with effects only in the IRT-X giving YOU a Wet/Dry set up – or return your FX into both the IRT-X and YOUR amps FX loop and run a truly massive stereo set up.

When more really does mean more.



The IRT-X can be scaled up to fit even the biggest rigs, with 2 IRT-X's YOU can run true W/D/W rigs with amazing sonic implications –it's like SONIC 3D!

The IRT-X has a super compact footprint which means YOU can have a massive sound on even the smallest stage, used in wedge mode or on a pole-stand.

Onstage Mic'ing

Mic-ing the IRT-X is simple! The IRT-X comes equipped with an XLR DI out! Which can be sent directly to the PA and provides either a completely dry signal, or can be cabinet emulated - with or without FX!

Emulation options include Dry, 1x12 or 4x12, so there is no need to use a mic & stand, which on a tight stage is great news.

The on-board DI also means YOU get the same great tone night after night, venue after venue – no more relying on mic placements!

Running a high tech DSP modelling setup?

Then the IRT-X is for you

The use of hi tech modelling setups requires some specific considerations when it comes to amplification. The IRT-X is ideally suited to pairing with a modelling processor or DSP based DAW package as the IRT-X has a completely flat, full range frequency response. Meaning YOUR carefully modelled signal path is not re-EQ'd during the amplification process.

AMPLIFIER SELECTION SWITCH

Gives you the option of connecting amplifiers with Less than 10W RMS or greater than 10W RMS.

FX

Use this to connect to your external FX processor. The level of signal is controlled by the Level control. If your FX processor has stereo outs then you can connect the left and rights independently. You could also send one of the returns back to your amps FX loop to run a stereo set up. (Any FX signal on the Mono Return is mirrored to the Line Out socket).

CABINET EMULATION FEATURE

Switch in a 1 x 12 or a 4 x 12 Cabinet emulation feature to the DI out signal.

ADDITIONAL IRT-X FOR STEREO OPERATION

Use this socket to connect to an additional IRT-X and run in Stereo Mode to give you a massive sound. (See FX).

PA

Balanced XLR-DI out for sending your IRT-X signal direct to the PA – no need to mic your IRT-X. This signal can be with or without FX, Dry or with cabinet emulation.

MONOBLOC OPTION

Connect an external speaker cabinet here in order to utilise the IRT-X's 200 Watts RMS output section. Makes everything gigable!

Ensure that the selection switch is correctly set to either External or Internal to suit your rig!

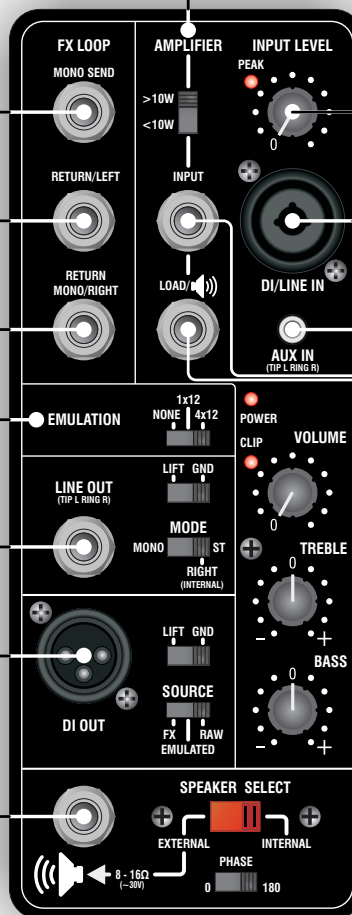

LEVEL CONTROL

Balances the amount of signal which appears at the FX-Loop send – makes sure that any external FX are driven at a desirable level.

FROM FX SEND, DI OUT TO DI/LINE IN

Connecting an IRT- Studio – use the on board balanced XLR Di out on your IRT-STUDIO to connect to the IRT-X using the combi XLR/Jack feature. This socket can also be used to connect other DSP based modelling products that are equipped with balanced XLR outs.

MP3 PLAYER

Use this socket for connecting an external sound source – the volume of the sound source is controlled by its on-board volume control.

ERL FEATURE

Connecting the IRT-X utilising the ERL feature. Simply remove your amps on-board speaker jack and connect the speaker output socket to the input of your IRT-X. Then connect the Load socket back to your amps internal speaker. If your amp has 2 speaker out sockets then there is no need to remove the on-board speaker – simply connect the IRT-X to the second speaker output and there is no need to adjust the amps impedance setting.



www.Laney.co.uk

PANEL CONTROLS

1. MAINS INLET SOCKET: IEC input for connection of an appropriate mains lead. Make sure the voltage indicated on the voltage selection switch is correct for your country!

2. MAINS SWITCH: Turns the system on and off. Ensure the level controls are at minimum when switching on and off.

3. Voltage Selection Switch: This is factory set to the correct voltage for the region the product is supplied to. If necessary it can be reset by removing the mains lead and then loosening (but not removing) the screws securing the cover. The cover can then be pivoted away from the switch which can be moved to select the alternate voltage. **DO NOT** reconnect the mains lead until the cover is replaced and secured.

EQ CONTROLS: On Board EQ. Consisting of:

4. Active Bass control allowing boost and cut of the low-frequency response of the pre-amplifier. To give optimum levels adjust gain till the peak LED just illuminates on the very loudest passages.

5. Active Treble control allowing boost or cut of the high frequency response of the pre-amplifier.

6. MASTER VOLUME: Controls the overall level of the IRT-X

7. CLIP LED: Illuminates just before the amplifier begins to clip and distort.

Adjust the level controls and signal level from your source so this illuminates only briefly on peaks in the music. Using the system with this LED on all or much of the time will result in poor sound quality and possible damage to speakers and electronics.

8. POWER LED: This will illuminate when the power switch is operated, indicating that mains power is within the amplifier.

9 INFORMATION: Area relating to the amplifier: Serial Number, operational information, power rating, etc

(Always switch off and disconnect the power cord when not in use)

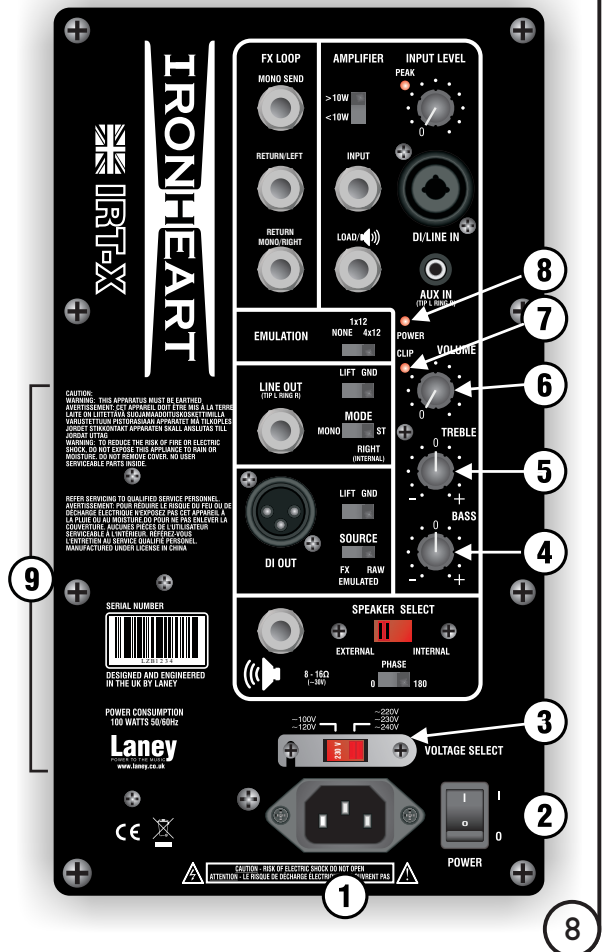

www.Laney.co.uk

SET UP OPTIONS



IRT-X



IRT-X



Connection Options

1. Remove the internal speaker jack from the rear panel of your amplifier, connect a lead from the IRT-X Input Socket to the internal speaker socket on your amplifier. Connect a lead from the Load Socket on the IRT-X to your internal speaker lead.
OR

2. If your amp has 2 speaker out sockets then there is no need to remove the on-board speaker— simply connect the IRT-X to the second speaker output and there is no need to adjust the amps impedance setting.

 **IRT-X**
AS A
PERSONAL
WEDGE MONITOR

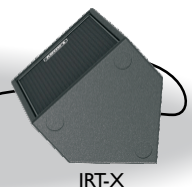

IRT-X

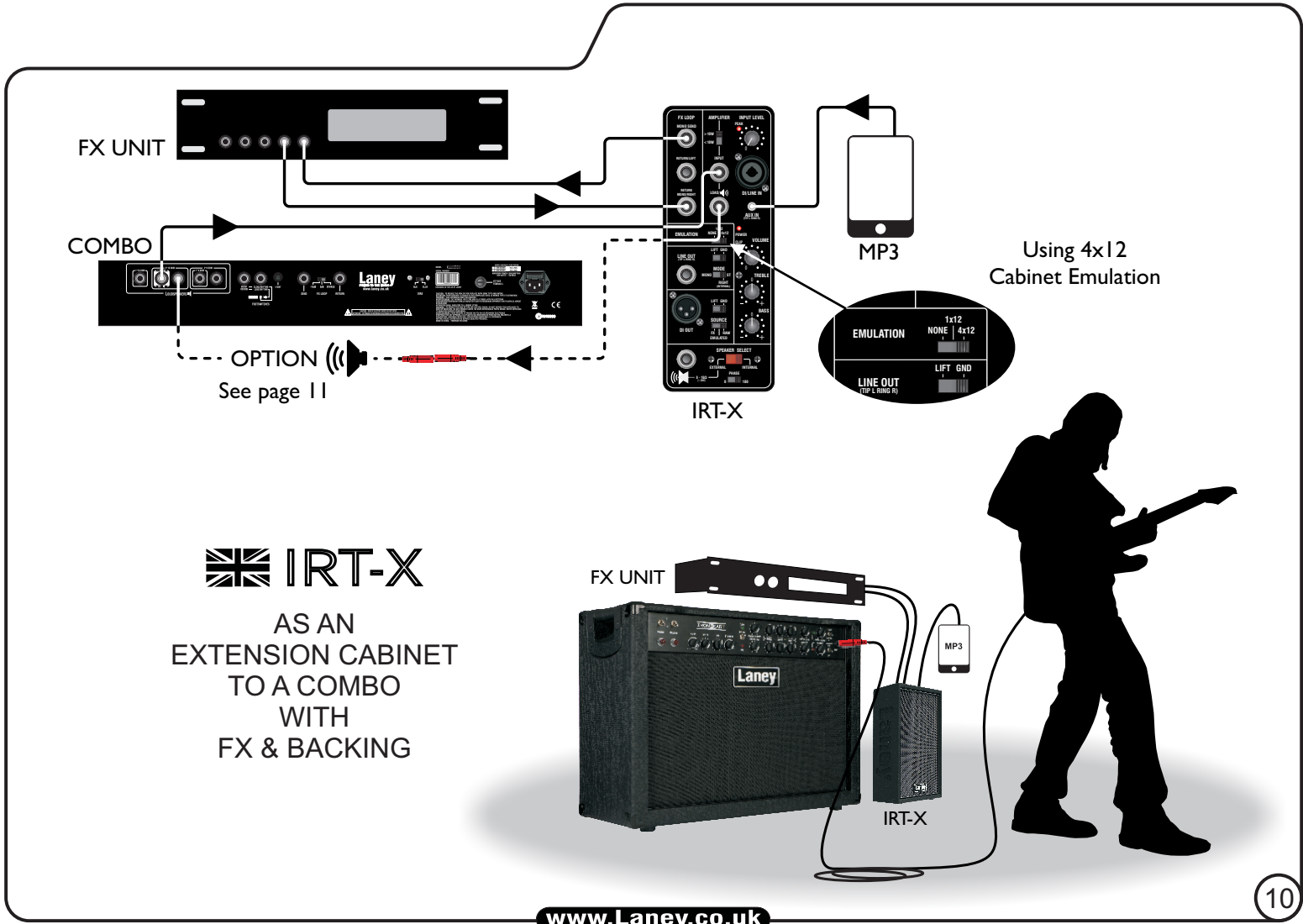

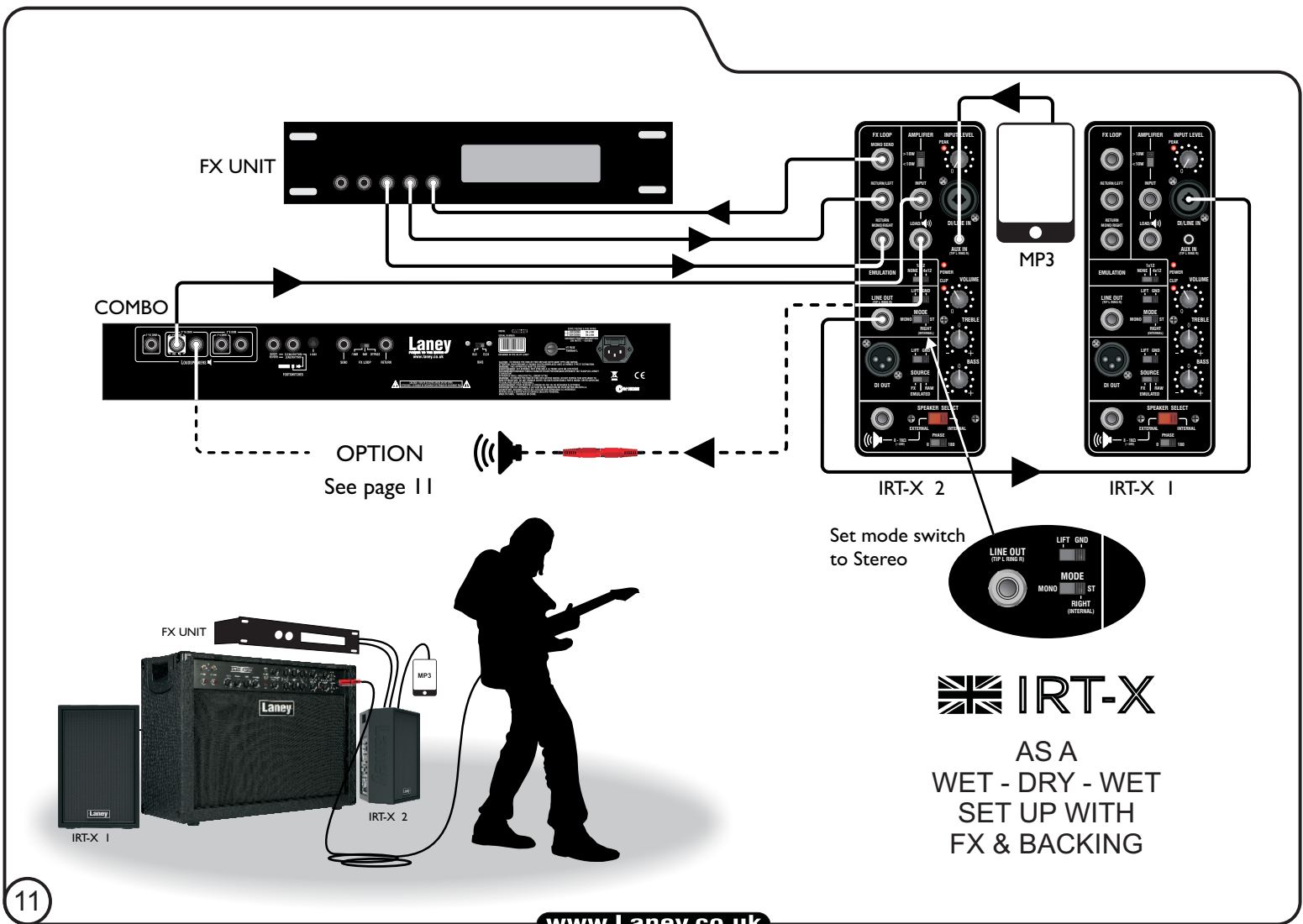

IRT-X
 AS A
 WET - DRY - WET
 SET UP WITH
 FX & BACKING

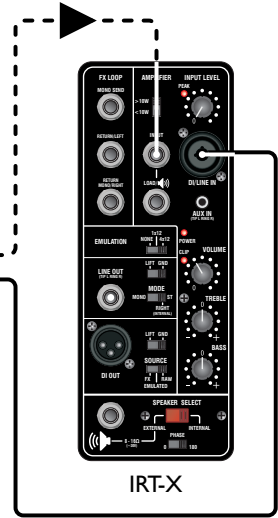
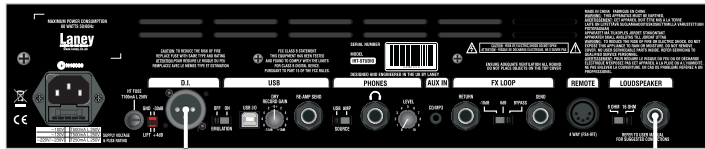

OPTION
 Connecting an IRT- Studio – use the on board balanced XLR Di out on your IRT-STUDIO to connect to the IRT-X using the combi XLR/Jack feature. (The Loudspeaker socket can also be used to connect to the IRT-X).



IRT-X
 IN USE WITH
 AN IRT-STUDIO

ACOUSTIC AMP



OPTION

The AI+ can be connected to the IRT-X using the DI Out when individual level control of the IRT-X's & the AI+ is required. If connected from the Line Out socket, then the AI+ has the master volume control.

IRT-X 1

IRT-X 2



Emulation switch set to None



Set mode switch to Stereo

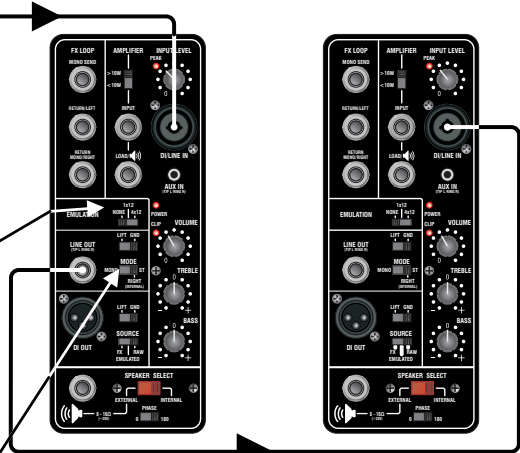

IRT-X 2

IRT-X 1

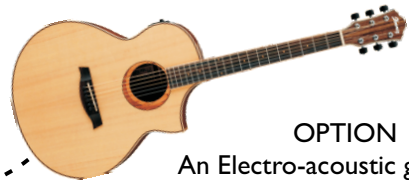

OPTION
An Electro-acoustic guitar can connect to the IRT-X directly using the Line In combi XLR/Jack feature.

IRT-X

IN USE WITH
ACOUSTIC AN AMPLIFIER

FCC Compliancy Statement

FC This device complies with Part 15 of the FCC rules.
Operation is subject to the following two conditions:

- 1) This device may not cause harmful interference
- 2) This device must accept any interference received, that may cause undesired operation.

Warning: Changes or modification to the equipment not approved by Laney can void the user's authority to use the equipment.

•**Note:** This equipment has been tested and found to comply with the limits for Class B digital device, pursuant to Part 15 of the FCC Rules. These limits are designed to provide reasonable protection against harmful interference in a residential installation. This equipment generates, uses and can radiate radio frequency energy and if not installed and used in accordance with the instructions, may cause harmful interference to radio communications. However, there is no guarantee that interference will not occur in a particular installation. If this equipment does cause harmful interference to radio or television reception, which can be determined by turning the equipment off and on, the user is encouraged to try and correct the interference by one or more of the following measures.

- Reorient or relocate the receiving antenna.
- Increase the separation between the equipment and receiver.
- Connect the equipment into an outlet on a circuit different from that to which the receiver is connected.
- Consult the dealer or an experienced radio/TV technician for help

CE This product conforms to the requirements of the following European Regulations, Directives & Rules:
CE Mark (93/68/EEC), Low Voltage 2006/95/EC, EMC (2004/108/EEC),
RoHS (EU2002/95/EC), WEEE (EU2002/96/EC)



In order to reduce environmental damage, at the end of its useful life, this product must not be disposed of along with normal household waste to landfill sites. It must be taken to an approved recycling centre according to the recommendations of the WEEE (Waste Electrical and Electronic Equipment) directive applicable in your country.

In the interest of continued development, Laney reserves the right to amend product specification without prior notification.

SPECIFICATIONS

Power Requirements:	~115V (~85V-132V) & ~230V (~170V-264V)(User selectable via panel switch)
Typical power consumption:	100W at 50-60Hz.
Amplifier power output:	200W into 4R @1%THD.
Amplifier topology:	High performance Class D with SMPS.
Loudspeakers:	1x8" Custom high power bass driver. 1" compression driver tweeter.
Crossover:	2 way passive with tweeter protection.
Line/Mic. Input sensitivity:	30mV (-28dBu) 10K Ohms Balanced. Maximum input 10V (+22dBu).
Amplifier Input sensitivity:	Recommended amplifier range 100mW-120Watts <10W 63mV (-22dBu) Peak ~20V (+28dBu) (220R balanced). >10W 775mV (0dBu) Peak ~200V (+48dBu) (220R balanced). Maximum continuous ~40V (+34dBu) Dissipation limited.
DI Output:	775mV (0dBu) Nominal (100R balanced). Selectable source: Input /Post Emulation/Post FX
Line Output:	775mV (0dBu) Nominal (1k Ohm unbalanced) Selectable: Mono out/Stereo Left out
FX Send:	388mV (-6dBu) Nominal (1k Ohms unbalanced)
FX Return L&R:	388mV (-6dBu) Nominal (10k Ohms unbalanced)
Auxiliary Input:	Stereo 388mV (-6dBu) (10K Ohms unbalanced)
External Speaker:	Recommended: 8 Ohms (100W), 16 Ohms (60W), 4 Ohms 200W (Minimum Load Impedance) (Floating output do not ground either terminal)
Amplifier Power range:	40Hz-35kHz -3dB (40Hz 3 rd Order HPF)
Distortion:	<0.01% THD+N
Unit Dimensions:	H425,W280,D265 Weight: 11.5Kg

BLOCK DIAGRAM

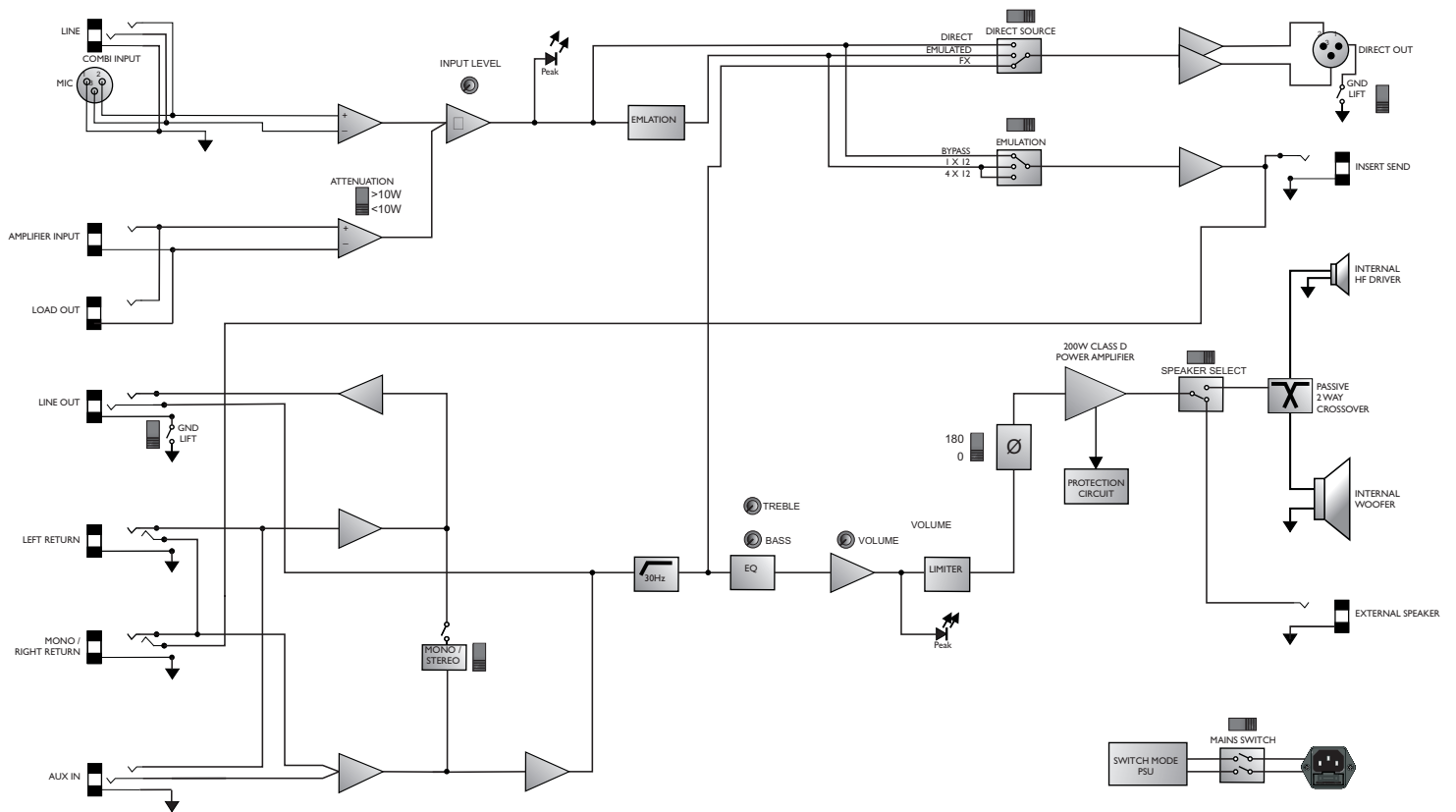



IMPORTANT SAFETY INSTRUCTIONS

WARNING: When using electrical products, basic cautions should always be followed, including the following:

1. Read these instructions.
2. Keep these instructions safe.
3. Heed all warnings.
4. Follow all instructions.
5. Do not use this apparatus near water.
6. Clean only with a dry cloth.
7. Do not block any of the ventilation openings. Install in accordance with manufacturer's instructions.
8. Do not install near any heat sources such as radiators, heat registers, stoves or other apparatus (including amplifiers) that produce heat.
9. An apparatus with Class I construction shall be connected to a mains socket outlet with a protective connection. Do not defeat the safety purpose of the polarized or grounding-type plug. A polarized plug has two blades with one wider than the other. A grounding type plug has two blades and a third grounding prong. The wide blade or third prong is provided for your safety. If the provided plug does not fit into your outlet, consult an electrician for replacement of the obsolete outlet.
10. Protect the power cord from being walked on or pinched, particularly at plugs, convenience receptacles, and the point they exit from the apparatus.
11. Only use attachments/accessories provided by the manufacturer.
12. Use only with a cart, stand, tripod, bracket, or table specified by the manufacturer, or sold with the apparatus. When a cart is used, use caution when moving the cart/apparatus combination to avoid injury from tip-over.
13. The mains plug or appliance coupler is used as the disconnect device and shall remain readily operable. The user should allow easy access to any mains plug, mains coupler and mains switch used in conjunction with this unit thus making it readily operable. Unplug this apparatus during lightning storms or when unused for long periods of time.
14. Refer all servicing to qualified service personnel. Servicing is required when the apparatus has been damaged in any way, such as when power-supply cord or plug is damaged, liquid has been spilled or objects have fallen into the apparatus, the apparatus has been exposed to rain or moisture, does not operate normally, or has been dropped.
15. Never break off the ground pin. Connect only to a power supply of the type marked on the unit adjacent to the power supply cord.
16. If this product is to be mounted in an equipment rack, rear support should be provided.
17. Note for UK only: If the colours of the wires in the mains lead of this unit do not correspond with the terminals in your plug, proceed as follows:
 - a) The wire that is coloured green and yellow must be connected to the terminal that is marked by the letter E, the earth symbol, coloured green or coloured green and yellow.
 - b) The wire that is coloured blue must be connected to the terminal that is marked with the letter N or the colour black.
 - c) The wire that is coloured brown must be connected to the terminal that is marked with the letter L or the colour red.
18. This electrical apparatus should not be exposed to dripping or splashing and care should be taken not to place objects containing liquids, such as vases, upon the apparatus.
19. Exposure to extremely high noise levels may cause a permanent hearing loss. Individuals vary considerably in susceptibility to noise-induced hearing loss, but nearly everyone will lose some hearing if exposed to sufficiently intense noise for a sufficient time.

The U.S. Government's Occupational Safety and Health Administration (OSHA) has specified the following permissible noise level exposures: According to OSHA, any exposure in excess of the above permissible limits could result in some hearing loss. Earplugs or protectors to the ear canals or over the ears must be worn when operating this amplification system in order to prevent a permanent hearing loss, if exposure is in excess of the limits as set forth above. To ensure against potentially dangerous exposure to high sound pressure levels, it is recommended that all persons exposed to equipment capable of producing high sound pressure levels such as this amplification system be protected by hearing protectors while this unit is in operation.

Duration Per Day in Hours	Sound Level dBA, slow response
8	90
6	92
4	95
3	97
2	100
1 1/2	102
1	105
1/2	110
1/4 or less	115

	<p>Intended to alert the user to the presence of uninsulated 'Dangerous Voltage' within the products enclosure that may be sufficient to constitute a risk of electrical shock to persons.</p> <p>Ce symbole est utilise pur indiquer a l'utilisateur de ce produit de tension non-isolee dangereuse pouvant etre d'intensite suffisante pour constituer un risque de choc electrique.</p> <p>Este simbolo tiene el proposito de alertar al usuario de la presencia de '(voltaje) peligroso' que no tiene aislamiento dentro de la caja del producto que puede tener una magnitud suficiente como para constituir riesgo de corrientazo.</p> <p>Dieses Symbol soll den Anwender vor unisolierten gefahrlichen Spannungen innerhalb des Gehauses warnen, die von Ausreichender Starke sind, um einen elektrischen Schlag verursachen zu konnen.</p>
	<p>Intended to alert the user of the presence of important operating and maintenance (Servicing) instructions in the literature accompanying the product.</p> <p>Dieses Symbol soll den Anwender vor unisolierten gefahrlichen Spannungen innerhalb des Gehauses warnen, die von Ausreichender Starke sind, um einen elektrischen Schlag verursachen zu konnen.</p> <p>Este simbolo tiene el proposito de la alertar al usuario de la presencis de instrucccones importantes sobre la operacion y mantenimiento en la literatura que viene conel producto.</p> <p>Dieses Symbol soll den Benutzer auf wichtige Instruaktionen in der Bedienungsanleitung aufmerksam machen, die Handhabung und Wartung des Produkts betreffen.</p>
<p>CAUTION:</p> <p>ATTENTION:</p> <p>PRECAUCION:</p> <p>VORSICHT:</p>	<p>Risk of electrical shock - DO NOT OPEN. To reduce the risk of electrical shock, do not remove the cover. No user serviceable parts inside. Refer servicing to qualified personnel.</p> <p>Risques de choc electrique - NE PAS OUVIRIR Afin de reduire le risque de choc electrique, ne pas enlever le couvercle. Il ne se trouve a l'interieur aucune piece pouvant etre reparee par l'utilisateur. Confier l'entretien a un personnel qualifie.</p> <p>Riesgo de corrientazo - no abra Para disminuir el risego de corrientazo, no abra la cubierta. No hay piezas adentro que el pueda reparar. Deje todo mantenimiento a los tecnicos calificados.</p> <p>Risiko - Elektrischer Schlag! Nicht offen! Um das Risiko eines elektrischen Schlages zu vermeiden, nicht die Abdeckung entfernen. Es befinden sich keine Teile darin, die vom Anwender repariert werden Konnten. Reparaturen nur von qualifiziertem Fachpersonal durchfuhren lassen.</p>
<p>WARNING:</p> <p>ADVERTISSEMENT:</p> <p>ADVERTENCIA:</p> <p>ACHTUNG:</p>	<p>To prevent electrical shock or fire hazard, do not expose this appliance to rain or moisture. Before using this appliance please read the operating instructions for further warnings.</p> <p>Afin de prevenir les risques de decharge electrique ou de feu, n'exposez pas cet appareil a la pluie ou a l'humidite. Avant d'utiliser cet appareil, lisez les advertissements supplementaires situes dans le guide.</p> <p>Para evitar corrientazos o peligro de incendio, no deja expuesto a la lluvia o humedad este aparato Antes de usar este aparato, lea mas advertcias en la guia de operacion.</p> <p>Um einen elektrischen Schalg oder Feuergefahr zu vermeiden, sollte dieses Gerat nicht dem Regen oder Feuchtigkeit ausgesetzt werden. Vor Inbetriebnahme unbedingt die Bedienungsanleitung lesen.</p>

After unpacking your amplifier check that it is factory fitted with a three pin 'grounded' (or earthed) plug. Before plugging into the power supply ensure you are connecting to a grounded earth outlet.

If you should wish to change the factory fitted plug yourself, ensure that the wiring convention applicable to the country where the amplifier is to be used is strictly conformed to. As an example in the United Kingdom the cable colour code for connections are as follows.

EARTH or GROUND GREEN/YELLOW
NEUTRAL - BLUE
LIVE - BROWN

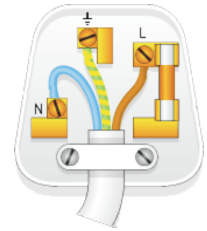

NOTE

This manual has been written for easy access of information. The front and rear panels are graphically illustrated, with each control and feature numbered. For a description of the function of each control feature, simply check the number with the explanations adjacent to each panel.

Your Laney amplifier has undergone a thorough two stage, pre-delivery inspection, involving actual play testing.

When you first receive your Laney guitar amplifier, follow these simple procedures:

(i) Ensure that the amplifier is the correct voltage for the country it is to be used in.

(ii) Connect your instrument with a high quality shielded instrument cable. You have probably spent considerable money on your amplifier and guitar - don't use poor quality cable it won't do your gear justice.

Please retain your original carton and packaging so in the unlikely event that some time in the future your amplifier should require servicing you will be able to return it to your dealer securely packed.

Care of your Laney amplifier will prolong it's life.....and yours!

www.Laney.co.uk

OPERATING INSTRUCTIONS - ISSUE 1.1

